

# Assembly Instructions for Desk Mount Brackets

For Acrylic Panels (PLTAP) use the shorter bolt (M6 x 20mm) and discard longer bolt.

For Fabric Panels (PLTFP) use the longer bolt (M6 x 25mm) and discard shorter bolt.

## Acrylic Panel (PLTAP)

## Fabric Panel (PLTFP)

### PLTSBUDMDUALSI

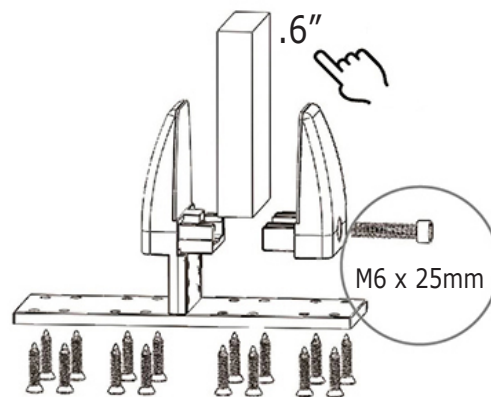
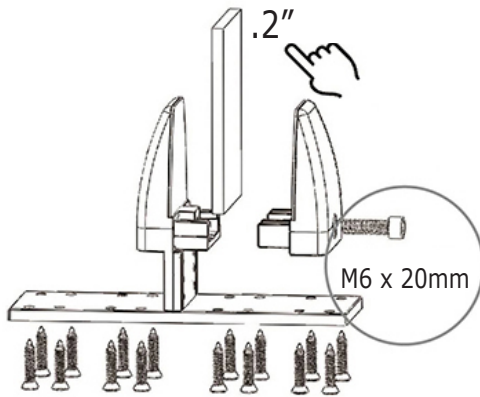

### PLTSDTMSI

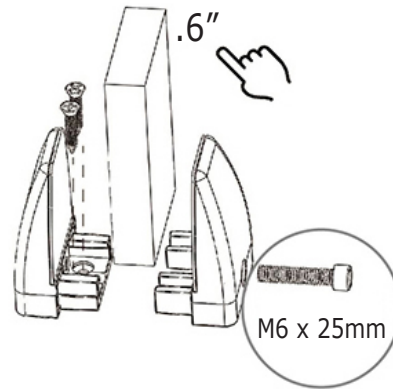
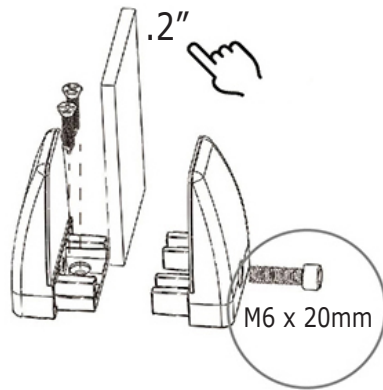

### PLTSBUDMSGLSI

